

INNOVATIVE PRODUCTS | SUPERIOR QUALITY | OUTSTANDING SERVICE

Profile Bar & Wedge Wire Buyer's Handbook

Screen Products From Hendrick

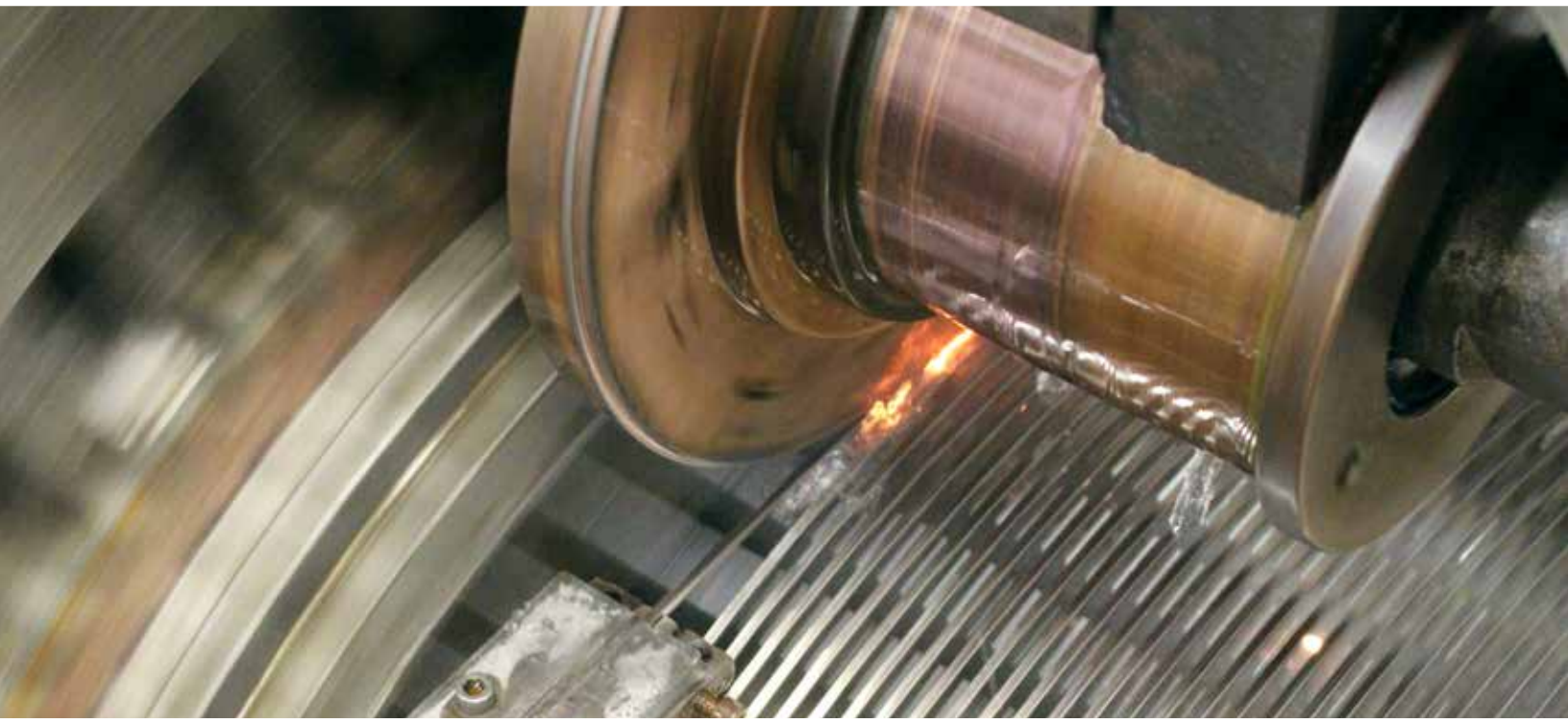

270-685-5138 | SCREEN@HENDRICKCORP.COM

OUR MANUFACTURING FACILITY



Founded in 1974, Owensboro, KY is home to Hendrick's 31,000 square foot production facility. Strategically located, we provide fast and dependable products to all corners of the United States—and beyond. Our quality management system is certified to the latest ISO 9001:2015 standards, which assures extremely reliable goods and services.

“You make a great product and have excellent customer service. We have enjoyed working with your company.”

“Sales and customer service dept. are great. Never had any trouble getting what I needed.”

HENDRICK SCREEN COMPANY

PROFILE BAR AND WEDGE WIRE SOLUTIONS

Hendrick Screen Company is a global manufacturer of Profile Bar and wedge wire solutions. We supply diverse products to a wide range of markets, allowing us to leverage our knowledge and technologies across our broad customer base.

We believe that how we do business is as important as what we do. Our goal is to provide our customers with a seamless experience at every touchpoint. In addition to a competitive price, we provide quick turn-around, on-time delivery, ordering flexibility, and customer-focused solutions from a friendly staff.

Hendrick Screen is a wholly-owned subsidiary of Hendrick Manufacturing (est. 1876), one of the oldest metal fabricating companies in the U.S., providing a strong legacy of metal working expertise. Hendrick Screen began its manufacturing operations in 1974. Today, we deliver 40+ years of manufacturing expertise that our customers know they can trust.

We're the only U.S. screen manufacturer that offers both Profile Bar and wedge wire solutions, allowing us to provide an unbiased recommendation for the best option for your application.

Profile Bar

- Non-welded, proprietary interlocked construction
- One of the strongest systems available
- Long life
- Flatness to 0.060" to 0.090"
- Slot openings of 0.005" and up
- Profile Bar available in various slot openings, widths, heights and cap sizes
- Available flat, curved, or cylindrical
- Offered in a wide range of materials

Wedge Wire

- Resistance welded wire and rod construction
- Available flat or cylindrical
- Tapered openings allowing particles to pass through
- Slot sizes ranging from 0.002" and up
- As run cylinder diameters from 1.0" to 42"
- Offered in a wide range of materials

Fabricating

- Resistance Welding
- Plasma Cutting
- Water Jetting
- MIG & TIG Welding
- Drilling
- Rolling
- Bending
- Grinding
- Various surface finishes available



WHY HENDRICK?

Hendrick offers both wedge wire and our proprietary Profile Bar construction methods for our screen products. Each has its own unique advantages, and the choice depends on the application. Hendrick is the only American screen manufacturer that offers both Profile Bar and wedge wire solutions, allowing us to provide an unbiased recommendation on the best option for your specific needs.

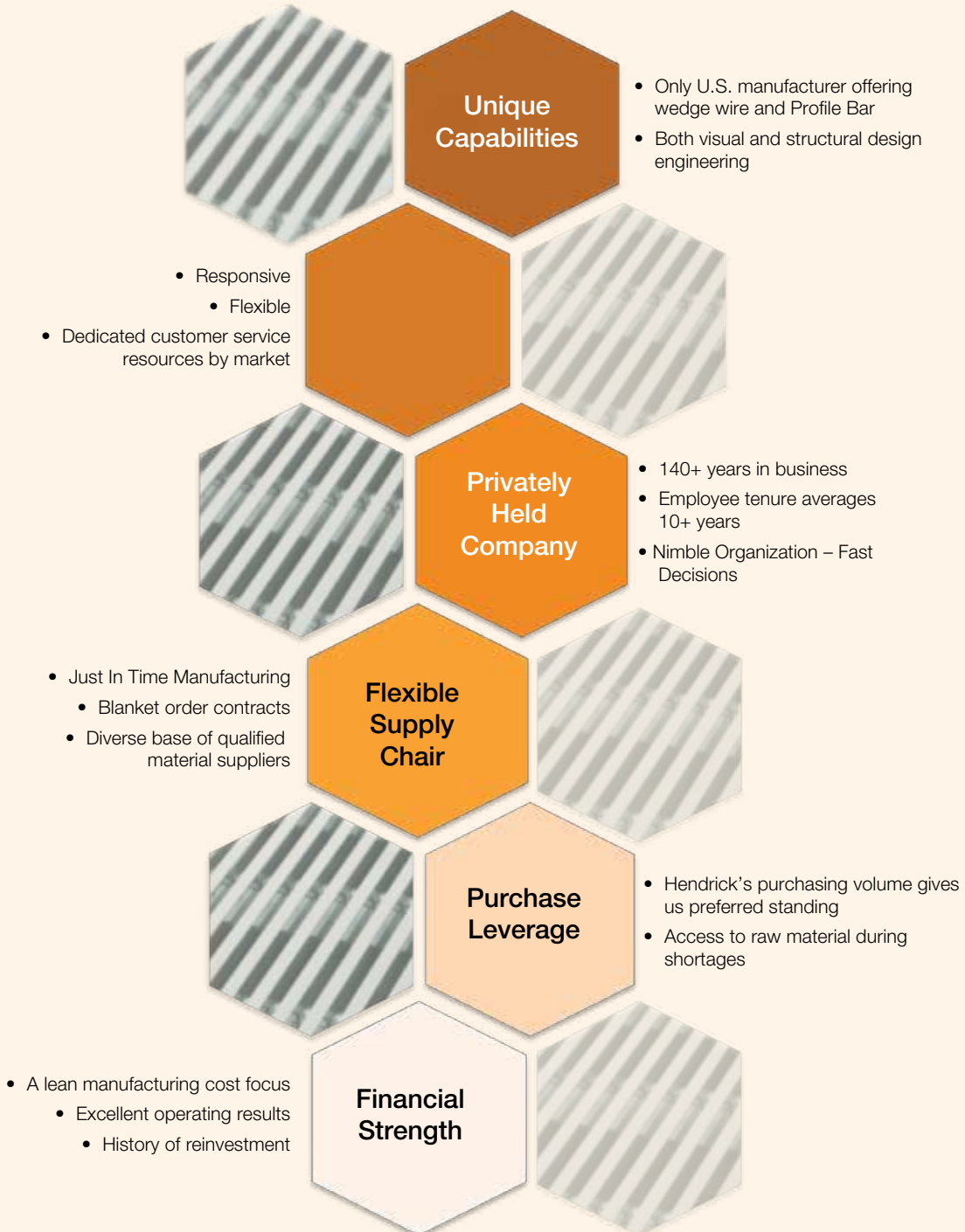

CAPABILITIES

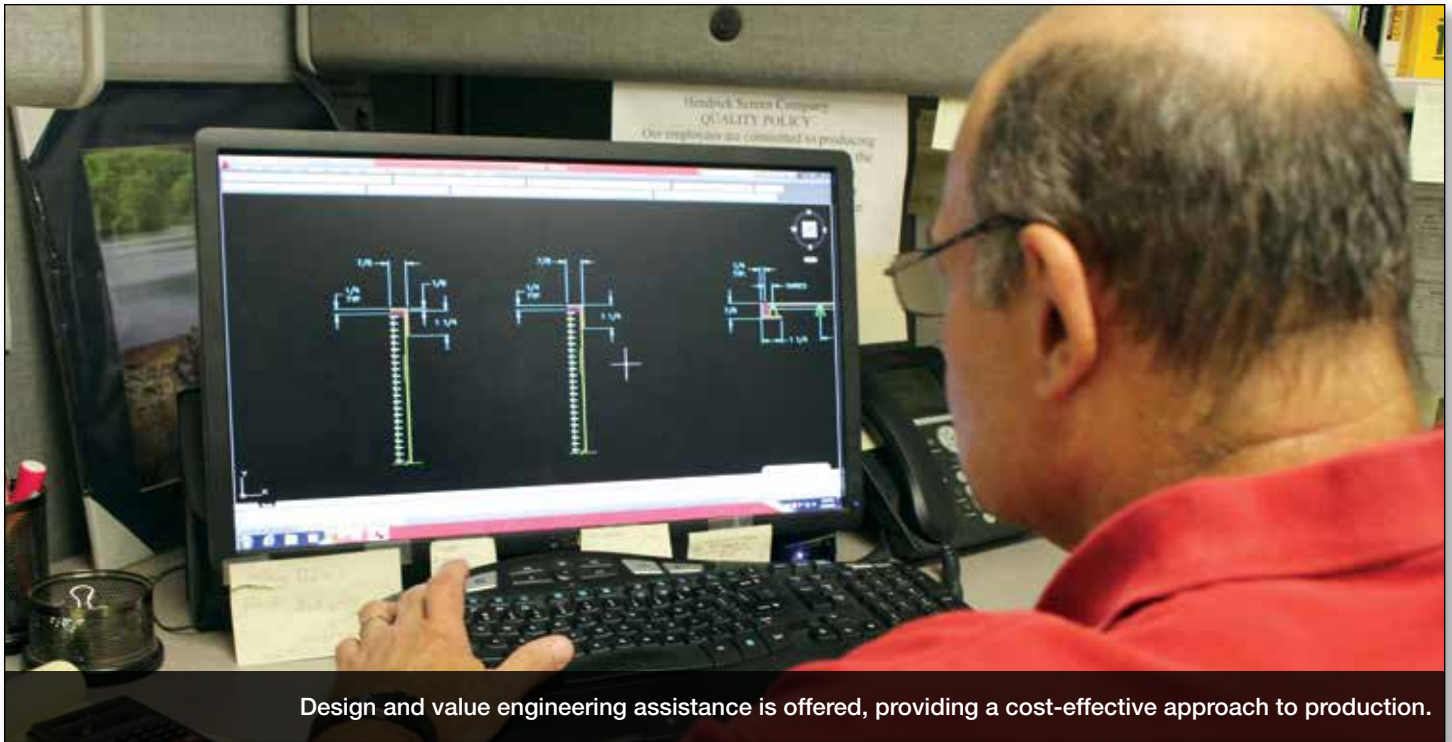

Design and value engineering assistance is offered, providing a cost-effective approach to production.

Engineering & Design Support Services

Our team is focused on supporting you and managing your projects. Our staff has the skills to track and manage complex metal fabrication and industrial metalwork projects. From basic projects, to those requiring complex and challenging solutions, Hendrick provides quality driven design assistance. We promote collaboration with our customer's engineering staff at each stage in the product life cycle.

Services include:

- Prototype design & build, product development, and production engineering support
- Revision control and product data management throughout the production cycle
- Design assistance for one-time or repetitive applications

We accept multiple CAD file formats



Hendrick keeps a wide variety of wire sizes in inventory.

Material Options

We maintain a large stock of materials to get you what you need, when you want it. Our long-term, close relationships with our raw material suppliers offers us visibility and dependability, allowing us to provide excellent service to our customers. Plus, our buying power enables us to provide very competitive pricing and shortened lead times. The same competitive pricing is offered regardless of order size.

Profile Bar Material Options

- Stainless Steel
- Aluminum
- Copper-Nickel
- Carbon Steel
- Specialty Alloys

Wedge Wire Material Options

- Stainless Steel
- Copper-Nickel
- Specialty Alloys

Product Testing

- Positive Material Identification (PMI)
- Ultrasonic
- Chemical Analysis
- Dimensional
- Dye-Penetrant
- Mechanical Testing

PROFILE BAR

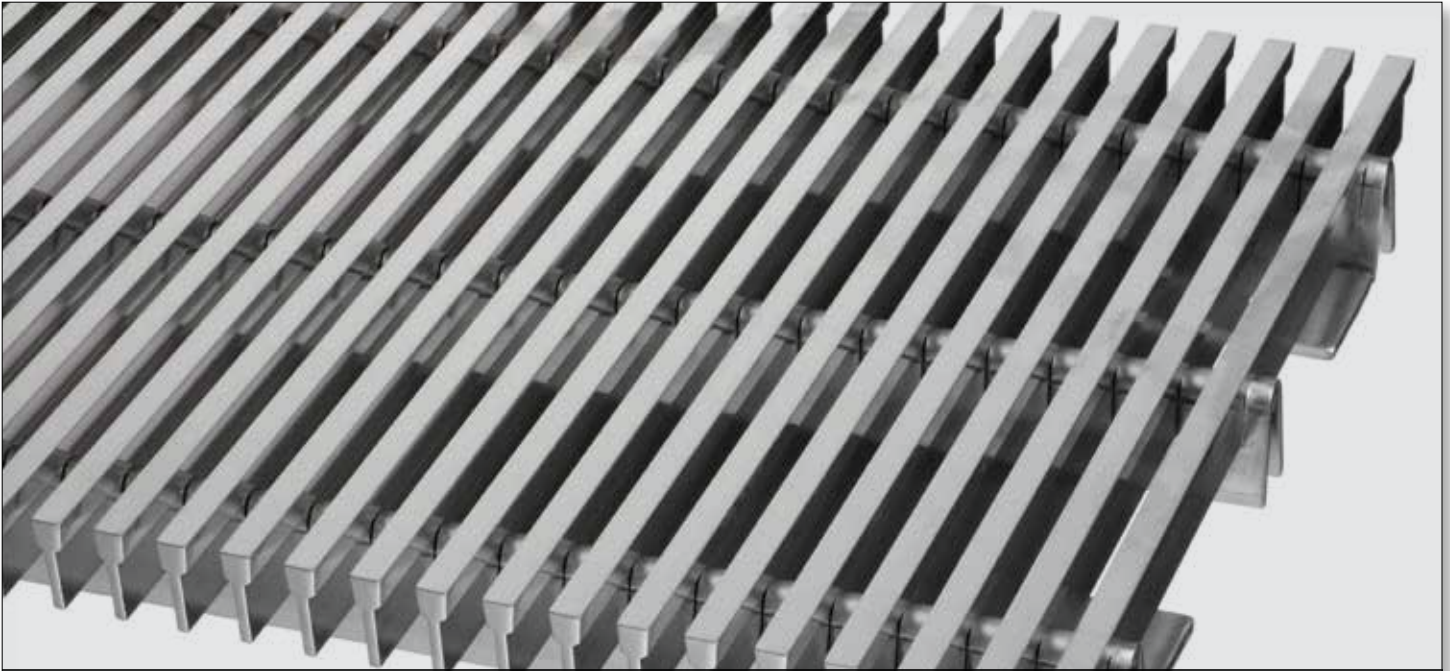

The superior construction of Profile Bar offers added strength and stiffness since the screens are an assembly, not a weldment.

Hendrick's Proprietary Construction Method

Hendrick's Profile Bar is suited to applications that require added strength or a very flat surface. Using a proprietary method of construction, the wires are mechanically interlocked to secure the bars into place, rather than welding the wire to supports. This manufacturing method provides increased strength, allowing it to withstand heavier loads and be more resilient to impact. Plus, the surface is much flatter, which requires less maintenance.

Advantages

- High strength
- High open area
- Carries heavy loads, including liquids
- Mechanical construction for longer life
- Won't crack or break like cast grates
- Design flexibility—Can be curved, straight or designed to match required shape

Options

- Flat, curved or cylindrical
- Slot openings from 0.005" and up
- Flatness between 0.06" to 0.09"
- Bar gauges between 0.069" to 0.50"
- 304L, 316L, Various Grades of Stainless & Exotic Alloys, Carbon, Aluminum (6061) in B9, B12 & T16







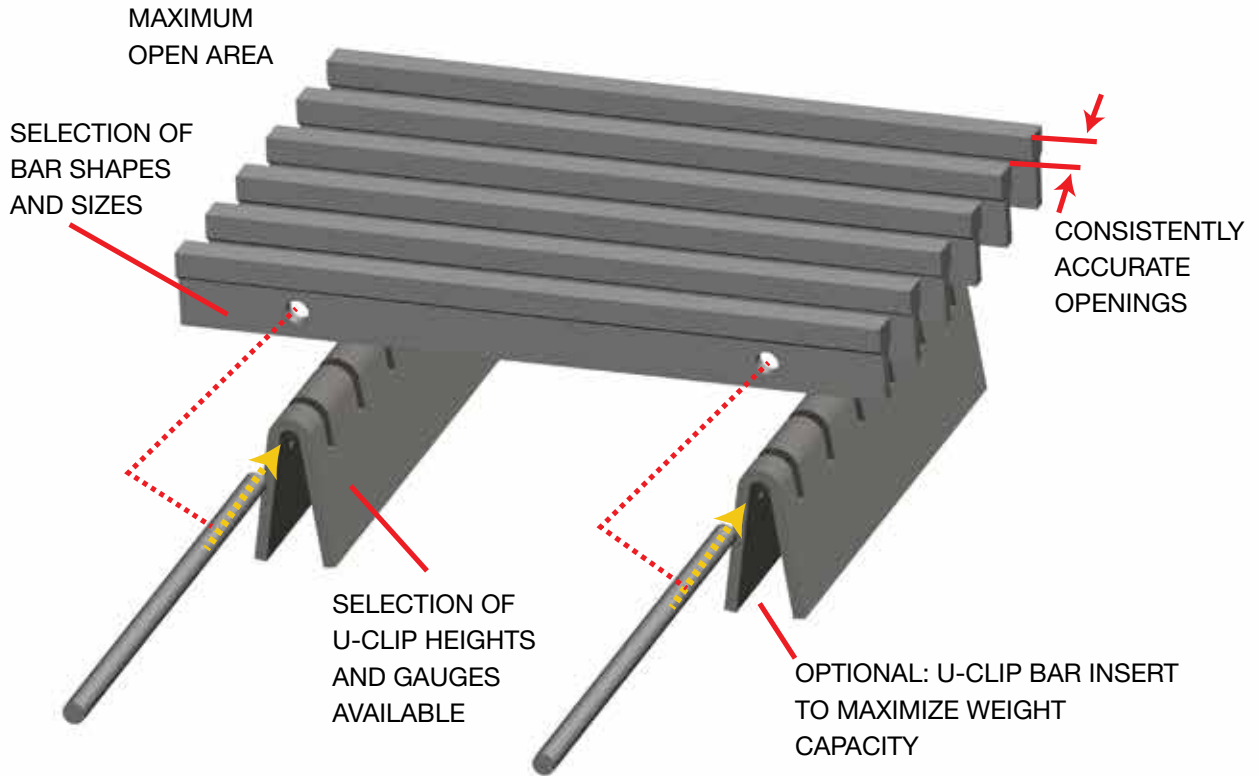







Profile bar can be manufactured to many configurations, including straight, curved and round.

Profile Bar Construction



Configuration Options

Multiple slot openings, widths, heights and cap sizes are offered.

| Profile Bar <small>images not to scale</small> |  |  |  |  |  |  |  |  |  |  |  |  |
|---|---|---|---|---|---|---|---|---|---|---|---|---|
| | B69 | B6S | B6 | B9S | B9 | B12 | T9M | T9 | F12 | T12 | T16 | T24 |
| Bar Width | .069 | .093 | .093 | .140 | .140 | .187 | .140 | .140 | .187 | .187 | .250 | .500 |
| Bar Height | .290 | .290 | .375 | .320 | .375 | .500 | .453 | .453 | .500 | .500 | .750 | .750 |
| Cap Height | .080 | .080 | .093 | .110 | .125 | .156 | .125 | .203 | .185 | .188 | .250 | .250 |

WEDGE WIRE



Hendrick can manufacture wedge wire in a wide variety of profile and support sizes.

Wedge wire, also known as profile wire or V-wire, can be configured to a variety of forms, sizes, and open areas. The result is a very strong product with a smooth surface that is resistant to clogging. This makes wedge wire advantageous for a diverse range of applications that require screening, filtering, dewatering, sizing, drying or cleaning.

Advantages

- Cost effective
- No moving parts
- High precision sizes
- High mechanical strength, lightweight construction
- Excellent filtration performance
- Minimizes clogging
- Maximum flow rates
- Resistant to temperature variations
- Long life

Options

- Slot openings from 0.002" and up
- Available flat, curved or cylindrical
- As run cylinders available from 1" to 42" diameter
- Axial or radial re-rolled
- Material Options: Stainless Steel 304L, 316L, Copper-Nickel and Specialty Alloys

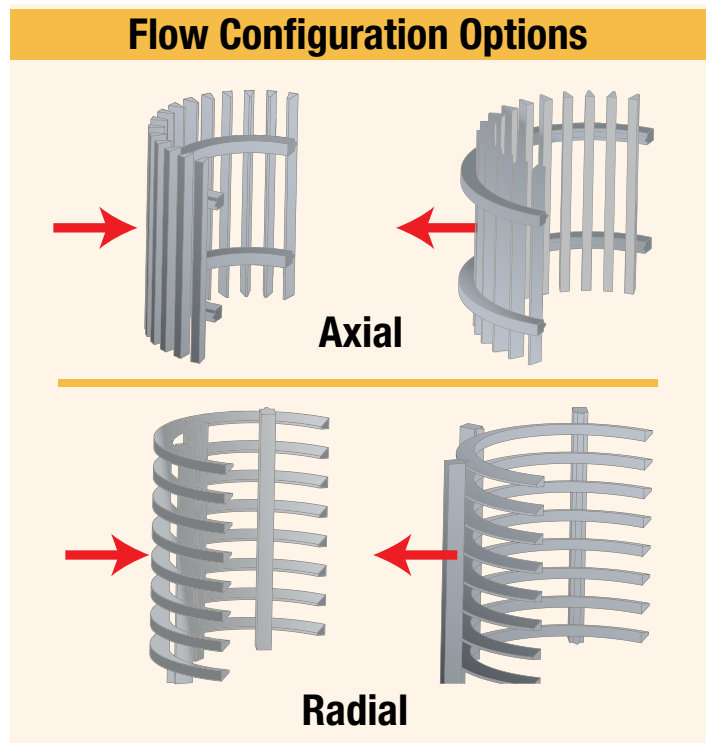

Wedge Wire Construction

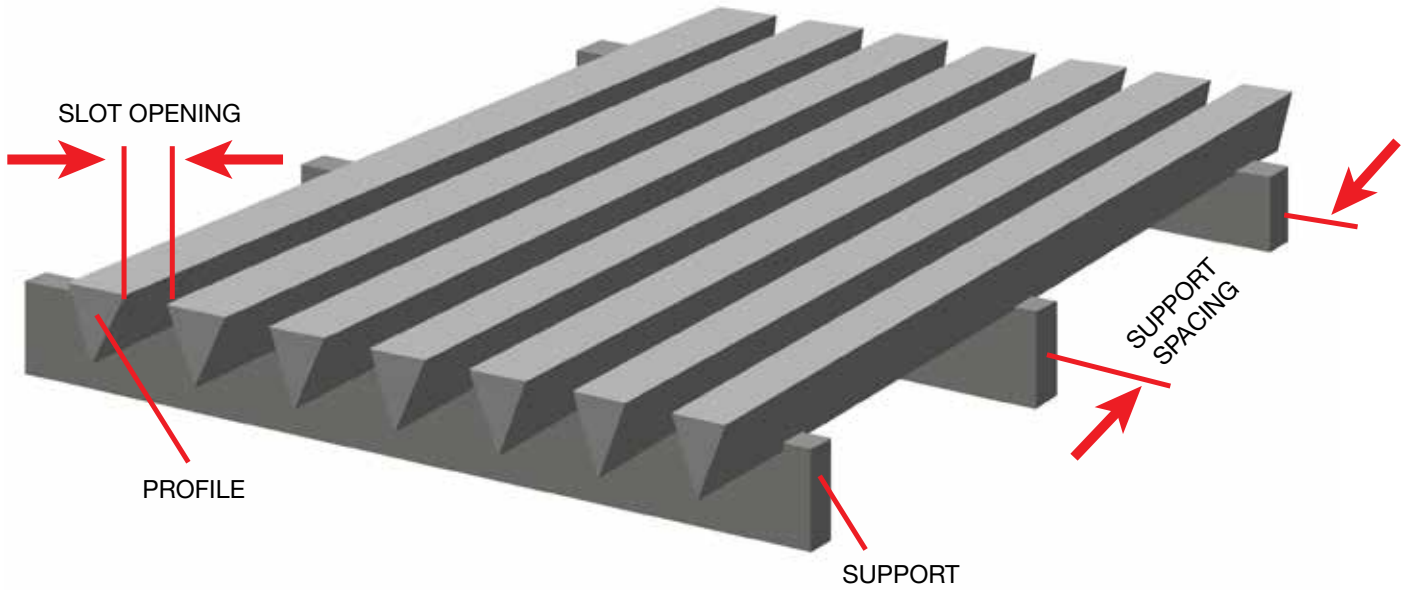

Configuration Options

| V-Wire <small>images not to scale</small> | 30V | 47V | 60V | 69SV | 69V | 90V | 125V | 130V |
|--|------|------|------|------|------|------|------|------|
| Width | .032 | .047 | .060 | .069 | .069 | .090 | .125 | .130 |
| Height | .075 | .098 | .100 | .125 | .185 | .150 | .200 | .310 |
| Relief Angle | 6.5° | 10° | 13° | 10° | 6° | 13° | 13° | 8° |

| Support <small>images not to scale</small> | .070x.50 | .070x.75 | .070x1 | .90Q | L90Q | 130Q | 130QT | .118x.185 |
|---|----------|----------|--------|------|------|------|-------|-----------|
| Width | .070 | .070 | .070 | .090 | .090 | .118 | .118 | .118 |
| Height | .500 | .750 | .100 | .160 | .125 | .197 | .272 | .185 |

FABRICATION



Hendrick's plasma cutting system produces quality cuts on a variety of materials.



Hendrick's welding services include MIG and TIG welding.

Our modern, ISO 9001 QMS certified facility houses equipment operating with the latest advances in manufacturing technology, enabling us to machine components to tight tolerances with superior quality. We offer complete end-to-end supply chain solutions with our broad range of fabricating capabilities.

Regardless of size, volume or material, our fabrication options can eliminate labor, time, and provide cost-savings for your completed assembly.

- Large to small components
- Prototype to production
- Partial to complete turn-key contract assembly operations
- Multiple finishing options available

Fabrication Services

- Bending
- Drilling
- Grinding
- Rolling
- Shearing
- Water Jet Cutting
- Plasma Cutting
- MIG, TIG Welding*
- Spot Welding
- Polishing

*Welders certified to Section 9 of ASME pressure Vessel Code.

“Pricing is timely and competitive, lead times are always good. Help in resolving issues is always top-notch.”

Hendrick's Profile Bar and wedge wire applications are engineered to provide solutions for a wide range of markets across the globe. We have many years of experience in every field of application. Whether you fit one of our major industries or a smaller, niche market, we have the manufacturing expertise and flexibility to provide quality materials for diverse and demanding applications.

FOOD & BEVERAGE

Hendrick produces Profile Bar and wedge wire products for several food and beverage applications. The unique design, built with high-grade stainless steel, offers both strength and a smooth surface that provides superior liquid /solid separation with minimized clogging.

- Dewatering screens
- Lauter screens / Mash tuns / False bottoms
- Sieve bends
- Sugar and starch processing screens
- Malting floors
- Flat panels or rotary screens

Benefits

- Meets hygienic requirements
- Excellent for kilning processes
- Minimizes cross-contamination
- Rotary screens can be produced to accommodate water flow direction

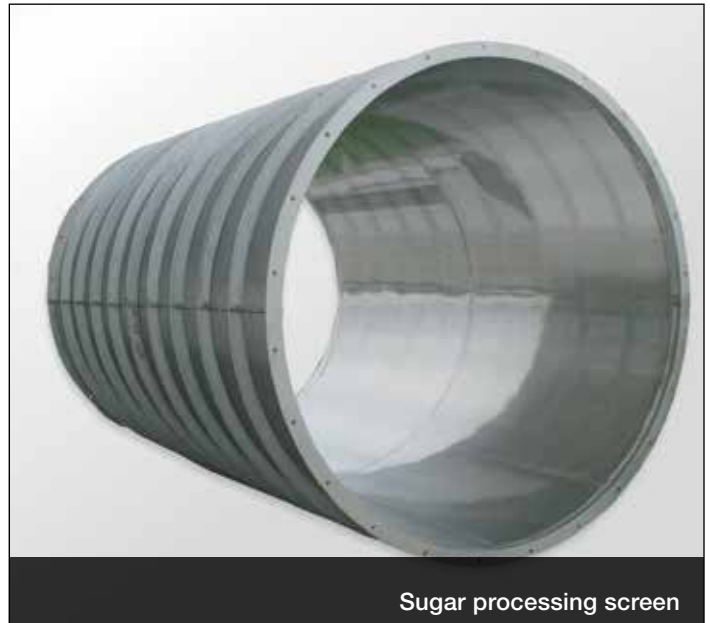

INDUSTRIAL FILTRATION

Hendrick offers filtration solutions as elements and sub-assemblies in static and dynamic systems, as filter and centrifuge segments, and as industrial design elements.

- Sieve screens
- Rotary/dewatering screens
- Conveyor screens
- Activated sludge processing
- Chip wringer screens
- OEM applications
- Header laterals
- Combined sewer/storm water screens



Benefits

- Precision filtering
- Ideal for high-temperature and high-pressure conditions
- Optimal performance with high flow rates
- Corrosion resistance
- Reduced plugging
- Suspended solid reduction in waste treatment applications



MARKETS

PULP & PAPER

Wedge wire and Profile Bar products are the optimal choice for separating particles during the pulp and paper filtration process. The wire design offers maximum throughput and reduces pressure drop over the screen. Hendrick produces parts for both OEM and replacement markets.

- Dewatering screens
- Pressure screens
- Sieve bends
- Liquor drainers
- Top separator baskets
- Chip chute screens

Benefits

- Maximum throughput
- Separation efficiency
- Fiber retention
- Reduces pressure drop
- Easy to clean



“You care about your customers and do everything possible to meet requests, such as expediting ship dates”

FISH DIVERSION

Hendrick’s fish diversion screens are used in water systems for protecting fish from entering hydroelectric turbines, pumps and irrigation canals. With no moving parts and easy installation, screens can be custom made to fit your application. Our screens are environmentally friendly to fish and other aquatic life and comply with NOAA standards.

- Flat panels
- Fish screens
- Baffle plates
- Bar screens
- Air manifolds

Benefits

- Reduces fish mortality
- 316(b) compliant, EPA’s best recommended technology
- Meets environmentally friendly guidelines
- Keeps turbines and pumps debris free
- Maintains reliable flow and less maintenance
- Ensures compliance with fish protection regulations

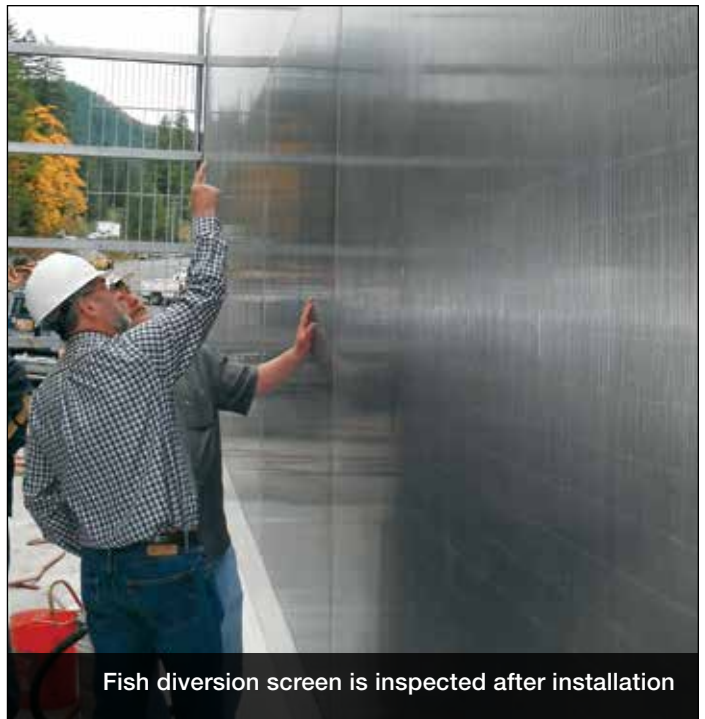

Fish diversion screen is inspected after installation

WATER INTAKE & WATER TREATMENT

Hendrick offers several cost-effective water intake options. Our Profile Bar and wedge wire construction methods are both 316(b) compliant and approved by NMFS. Material options include stainless steel and copper-nickel, for anti-biofouling (zebra mussel protection).

- T-intake screens
- Half-barrel intake screens (*U.S. Patent HSC 003 UAUS1*)
- Drum screens
- Flat panel screens
- Airburst systems

Benefits

- Passive - No moving parts
- Reduces operating costs
- Minimizes clogging
- Maximum water flow
- Multiple designs accommodate shallow to deep depths
- Copper-nickel for anti-biofouling
- 316(b) Compliant
- Corrosion-resistant

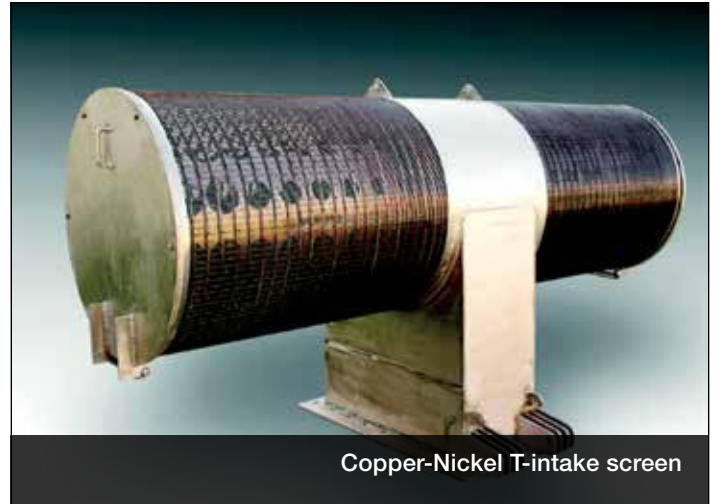

*“I love the quick response and follow up if required.
A very good company to deal with”*

AIRBURST CLEANING SYSTEM

Hendrick recommends an Airburst cleaning system to assure trouble-free, uninterrupted operations in high debris environments or where inadequate water currents can cause a buildup of sediments and organic matter on the intake screen, gradually restricting water flow. The Airburst cleaning system effectively removes the debris through a rapid release of high-pressure air.



Standard components of a turn-key Airburst system are:

1. Air-Compressor
2. Control Panel
3. Valves
4. Receiver



MARKETS

MINING & AGGREGATE

Profile Bar and wedge wire products can be used for sizing, grading and dewatering of mining and aggregate applications. Our products are fully customizable to fit most applications, including capacity requirements. We manufacture using high-strength stainless steel, which provides anti-high abrasion, corrosion and clogging resistance in the harshest conditions.

- Dewatering screens
- Sieve bends/DSM screens
- Flat panel screens
- Vibratory screens
- Cross flow sieves
- Centrifuge baskets
- Trommel screens

Benefits

- High strength / load capacity
- Withstands high level of vibration
- Longer service life
- High volume of separation and classification



“They deliver a quality product on time with great people to work with. First time working with Hendrick and was very impressed.”



Petrochemical collector basket

PETROCHEMICAL

Hendrick screens are used in many diverse applications such as media retention, hydro treating, de-sulfuring, sand filtering, and other adsorption processes. All are engineered to provide tight slot control with minimal plugging in order to decrease downtime and increase efficiency.

For rugged conditions, such as pressure > 50psi or high temperatures, we utilize our Profile Bar construction along with specially designed inserts to carry these loads without undue loss of screen efficiency.

- Support grids
- Catalyst support grids
- Scallops
- Header laterals
- Inlet baskets
- Outlet baskets
- Strainer baskets
- Media retention screens
- Nozzle screens

Benefits

- Tight slot control with minimal plugging
- Loads from 10–200 psi with close tolerances on slot openings from 0.005" and up.
- The combination of wire size and proper slot openings will provide optimal open area.

“Very good drawings. A+ customer service. Product quality is good.”

ARCHITECTURAL

Our wedge wire and proprietary Profile Bar designs are among the industry's most innovative. What's more, our custom fabrication services solve a variety of architectural challenges with products that offer the highest levels of quality and dependability.

We can work with you on any custom design or application.

Applications

Linear or curved options available

- Ceiling and Wall Cladding
- Column Covers
- Entrance Grilles & Revolving Door Mats
- Carpet inserts, Algrip and SlipNOT® Available
 - EZ Loc Mounting System For Easy Installation
- Stair Components
 - Infill Panels
 - Stair Risers
 - Stair Treads
- Tree Grating
- Trench Grating & Drain Covers
- Ventilation Grilles



Column cover

Benefits

- 140 years of metal working experience
- Environmentally responsible and energy-efficient materials
- Standard and custom metal solutions for interiors and exteriors
- LEED certified



HVAC floor grate

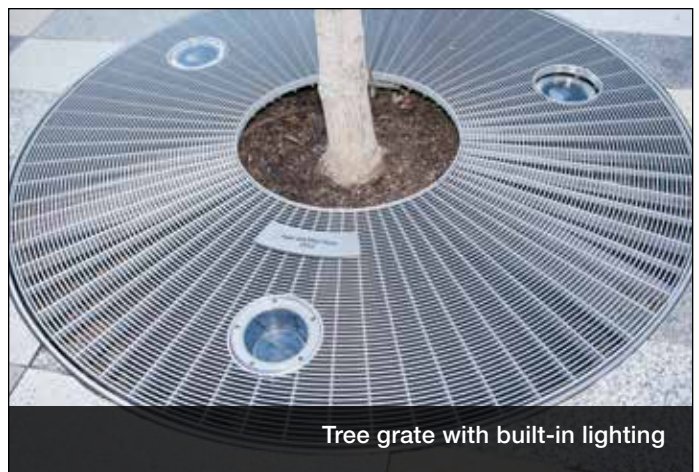

Tree grate with built-in lighting

“Extremely responsive to quotes and help with new designs.”

Hendrick delivers solutions that give you the competitive edge.

Contact us today to discuss your Profile Bar and wedge wire needs.

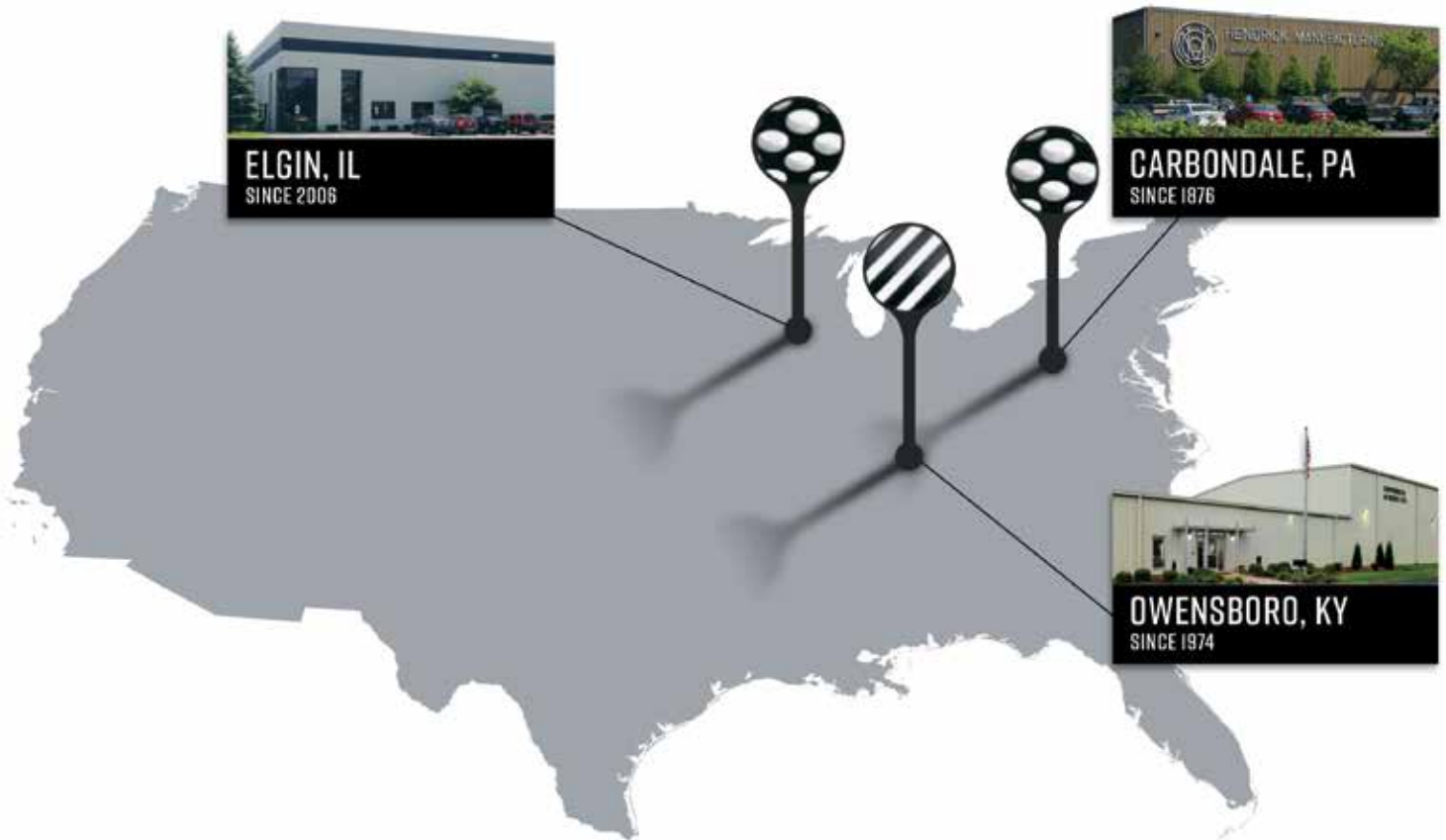

Hendrick Divisions

| Screen Solutions | Architectural Metals | Perforating & Fabrication | |
|--|--|--|--|
| <p>Hendrick Screen Company 3047 Medley Road Owensboro, KY 42301 www.hendrickscreen.com screen@hendrickcorp.com Phone: 270-685-5138 Fax: 270-685-1729</p> | <p>Hendrick Architectural 1 Seventh Avenue Carbondale, PA 18407 www.hendrickarch.com arch@hendrickcorp.com Phone: 877-840-0881 Fax: 570-282-1506</p> | <p>Hendrick Manufacturing 1 Seventh Avenue Carbondale, PA 18407 www.hendrick-perf-fab.com perf@hendrickcorp.com Phone: 800-225-7373 Fax: 570-282-1506</p> | <p>Hendrick Metal Products 1320 Gateway Drive Elgin, IL 60124 www.hendrick-perf-fab.com perf@hendrickcorp.com Phone: 847-742-7002 Fax: 847-742-7448</p> |

Each location
ISO 9001
 Registered

